



SGM4809

Dual 158mW Headphone Amplifier with Active Low Shutdown Mode

GENERAL DESCRIPTION

The SGM4809 is a dual audio power amplifier capable of delivering 158mW per channel of continuous average power with typically 0.1% distortion (THD+N) when it drives a 16Ω speaker from a 5.0V power supply. It is designed to maximize audio performance in portable applications such as mobile phone. The portable application requires audio power amplifier has minimum of external components and can operate from a single 2.5V to 5.5V power supply.

SGM4809 features an externally controlled, active-low, micro-power consumption shutdown mode, as well as an internal thermal shutdown protection mechanism.

SGM4809 does not require bootstrap capacitors or snubber networks. It is optimally suited for low power portable systems.

For maximum flexibility, the SGM4809 provides an externally controlled gain (with resistors), as well as an externally controlled turn-on time (with the bypass capacitor).

The SGM4809 is available in Green MSOP-8 package. It operates over an ambient temperature range of -40°C to +85°C.

FEATURES

- **Active-Low Shutdown Mode**
- **158mW into 16Ω Load from 5V Power Supply at THD+N = 0.1% (Typical, per Channel)**
- **87mW into 32Ω Load from 5V Power Supply at THD+N = 0.1% (Typical, per Channel)**
- **Unity Gain Stable**
- **Shutdown Current: 0.6μA (TYP)**
- **2.5V to 5.5V Operation**
- **Shutdown Pin is Compatible with 1.8V Logic**
- **Pop/Click Reduction Circuitry**
- **-40°C to +85°C Operating Temperature Range**
- **Available in Green MSOP-8 Package**

APPLICATIONS

Portable Systems
Headphone Amplifier
Microphone Preamplifier
Notebook Computers
Mobile Phone
PDAs
GPS

SGM4809

Dual 158mW Headphone Amplifier with Active Low Shutdown Mode

PACKAGE/ORDERING INFORMATION

MODEL	ORDER NUMBER	PACKAGE DESCRIPTION	PACKAGE OPTION	MARKING INFORMATION
SGM4809	SGM4809YMS/TR	MSOP-8	Tape and Reel, 3000	SGM4809YMS

ABSOLUTE MAXIMUM RATINGS

Supply Voltage	6V
Input Voltage	-0.3V to (V ₊) + 0.3V
Storage Temperature Range	-65°C to +150°C
Junction Temperature	150°C
Operating Temperature Range	-40°C to +85°C
Lead Temperature Range (Soldering 10sec)	260°C
ESD Susceptibility	
HBM	4000V
MM	400V

NOTE:

Stresses beyond those listed under “Absolute Maximum Ratings” may cause permanent damage to the device. These are stress ratings only, and functional operation of the device at these or any other conditions beyond those indicated in the operational sections of the specifications is not implied. Exposure to absolute maximum rating conditions for extended periods may affect device reliability.

CAUTION

This integrated circuit can be damaged by ESD if you don't pay attention to ESD protection. SGMICRO recommends that all integrated circuits be handled with appropriate precautions. Failure to observe proper handling and installation procedures can cause damage. ESD damage can range from subtle performance degradation to complete device failure. Precision integrated circuits may be more susceptible to damage because very small parametric changes could cause the device not to meet its published specifications.

SGMICRO reserves the right to make any change in circuit design, specification or other related things if necessary without notice at any time. Please contact SGMICRO sales office to get the latest datasheet.

PIN CONFIGURATION (TOP VIEW)

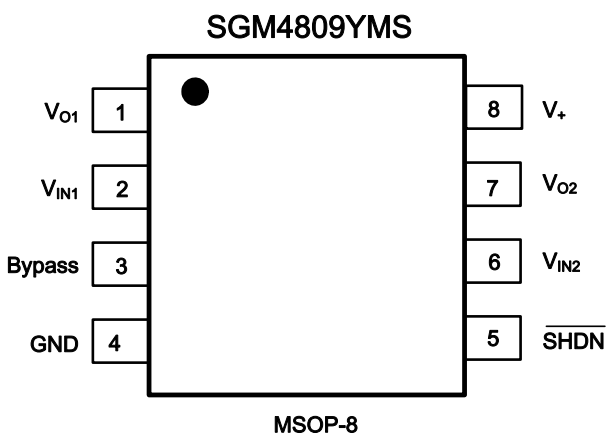

ELECTRICAL CHARACTERISTICS

(T_A = +25°C, unless otherwise specified.)

PARAMETER	SYMBOL	CONDITIONS		MIN	TYP	MAX	UNITS
Supply Voltage	V ₊			2.5		5.5	V
Shutdown Current	I _{SD}	V _{IN} = 0V, V _{SHDN} = GND, V ₊ = 5.0V			0.6	4	μA
		V _{IN} = 0V, V _{SHDN} = GND, V ₊ = 3.3V			0.18		
		V _{IN} = 0V, V _{SHDN} = GND, V ₊ = 2.6V			0.1		
Output Offset Voltage	V _{OS}	V _{IN} = 0V, V _{SHDN} = V ₊ = 5.0V		-50	5.3	50	mV
		V _{IN} = 0V, V _{SHDN} = V ₊ = 3.3V		-50	4.7	50	
		V _{IN} = 0V, V _{SHDN} = V ₊ = 2.6V		-50	4.4	50	
Quiescent Power Supply Current	I _Q	V _{IN} = 0V, V _{SHDN} = V ₊	V ₊ = 5.0V, No Load		1.83	2.8	mA
			V ₊ = 3.3V, No Load		1.72		
			V ₊ = 2.6V, No Load		1.65		
Shutdown Voltage Input High	V _{SDIH}			1.8			V
Shutdown Voltage Input Low	V _{SDIL}					0.4	V
Output Power (per Channel)	P _O	f = 1kHz, THD+N = 0.1%	V ₊ = 5.0V	R _L = 16Ω		158	mW
				R _L = 32Ω		87	
			V ₊ = 3.6V	R _L = 16Ω		84	
				R _L = 32Ω		47	
			V ₊ = 3.0V	R _L = 16Ω		58	
				R _L = 32Ω		33	
			V ₊ = 2.6V	R _L = 16Ω		42	
				R _L = 32Ω		25	
Total Harmonic Distortion + Noise	THD+N	P _O = 78mW, V ₊ = 5.0V, R _L = 32Ω, f = 20Hz to 20kHz			0.3		%
Crosstalk	X _{TALK}	R _L = 32Ω, P _O = 70mW, V ₊ = 5V, f = 1kHz			-100		dB
Power Supply Rejection Ratio	PSRR	f = 217Hz	V ₊ = 5.0V		-62	dB	
			V ₊ = 3.6V		-62		
			V ₊ = 3.0V		-62		
			V ₊ = 2.6V		-62		
		f = 1kHz	V ₊ = 5.0V		-71		
			V ₊ = 3.6V		-71		
			V ₊ = 3.0V		-71		
			V ₊ = 2.6V		-71		
Wake-Up Time	T _{WU}	V ₊ = 5.0V, C _{BYPASS} = 0.47μF, R _L = 16Ω			0.53		s

TYPICAL PERFORMANCE CHARACTERISTICS

Large Signal Step Response

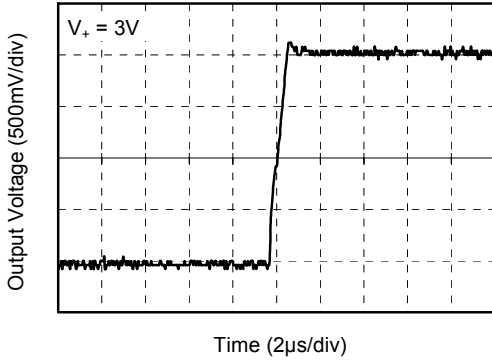

Small Signal Step Response

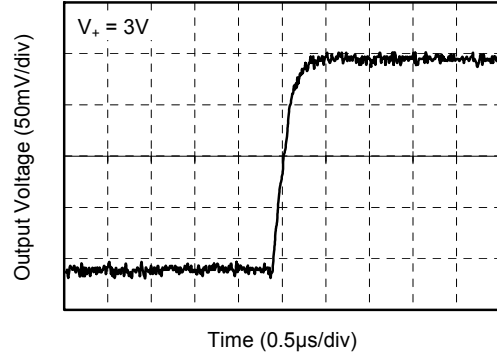

Large Signal Step Response

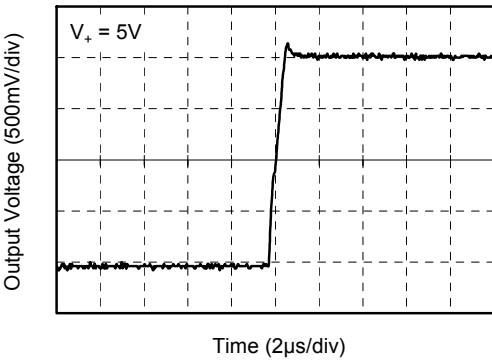

Small Signal Step Response

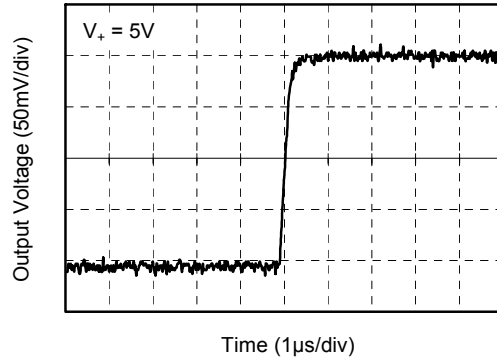

Small Signal Frequency Response

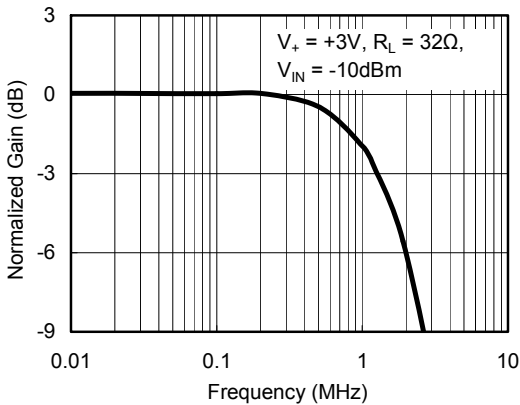

Small Signal Frequency Response

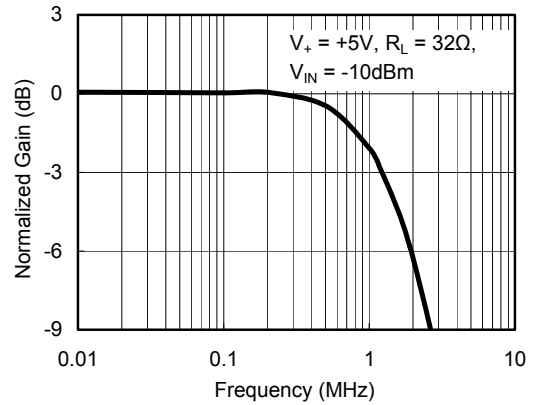

TYPICAL PERFORMANCE CHARACTERISTICS

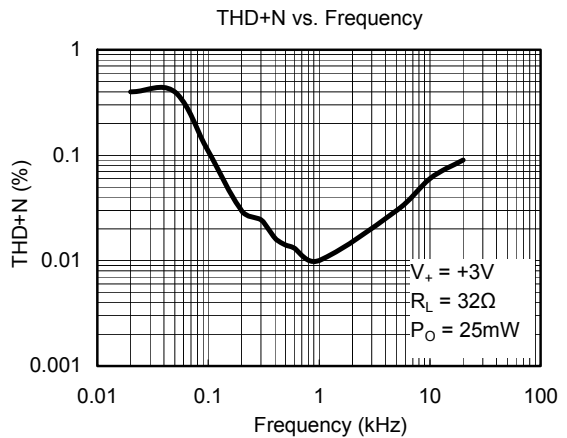
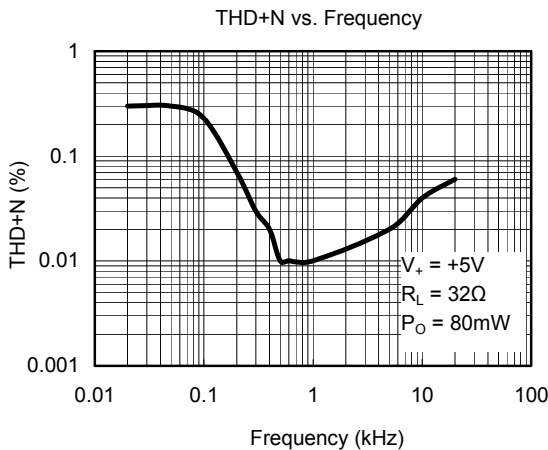
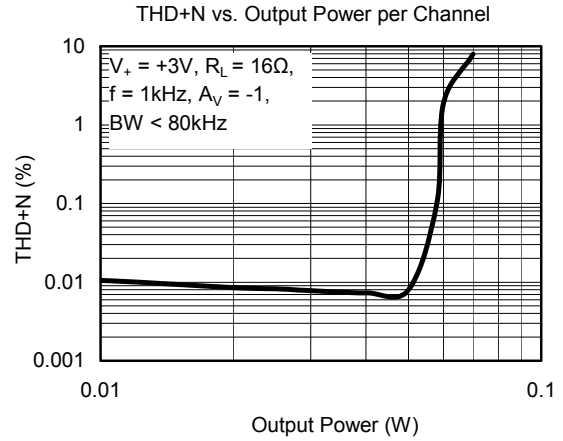
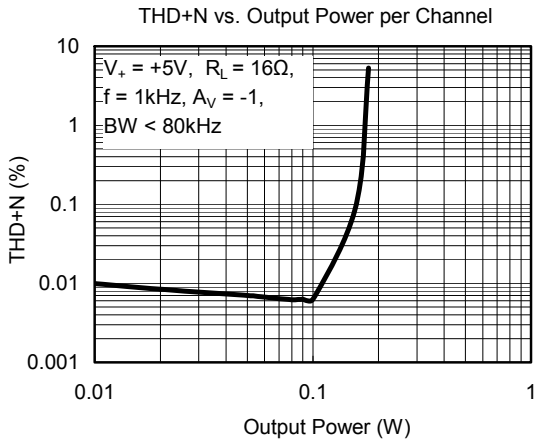
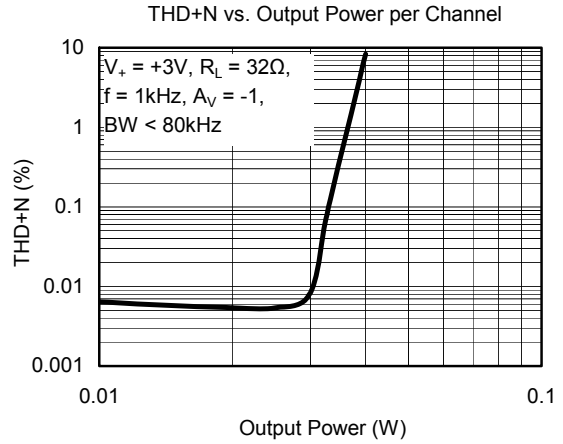
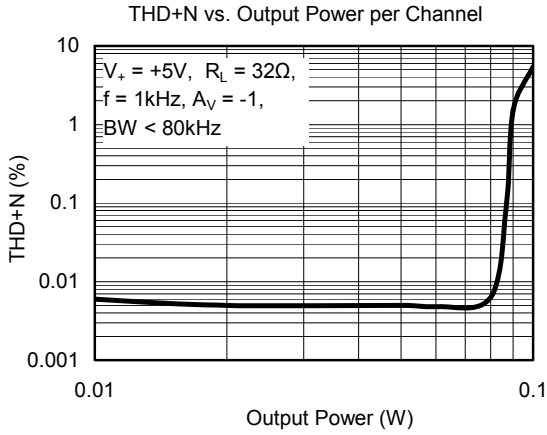

TYPICAL PERFORMANCE CHARACTERISTICS

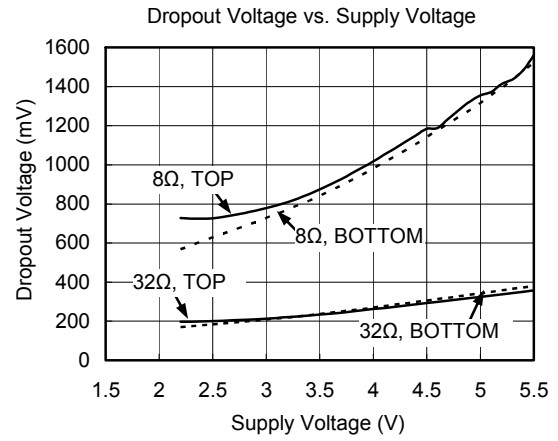
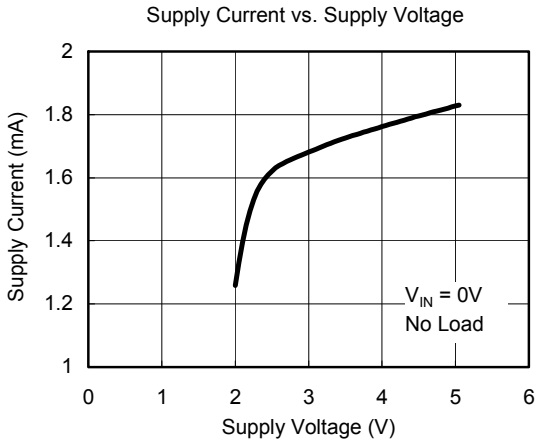

TYPICAL APPLICATION

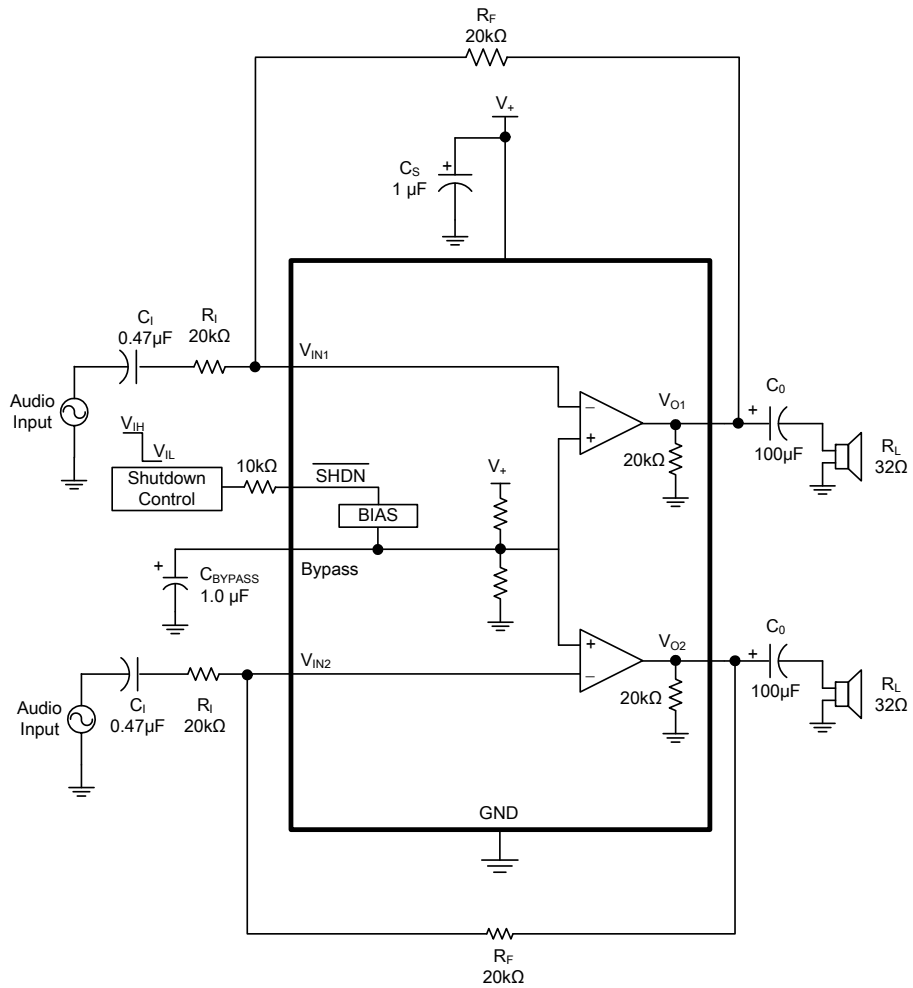

NOTE:

1. A 10k Ω resistor must be serially connected to $\overline{\text{SHDN}}$ pin.

PACKAGE OUTLINE DIMENSIONS

MSOP-8

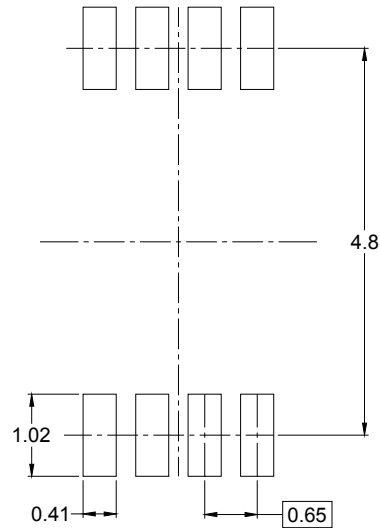
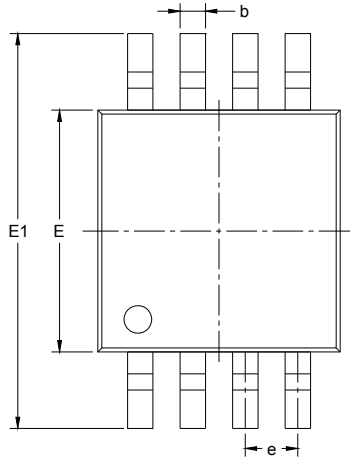

RECOMMENDED LAND PATTERN (Unit: mm)

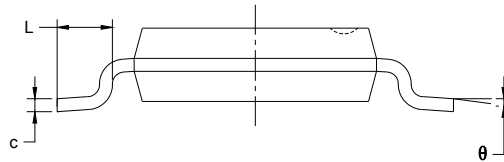
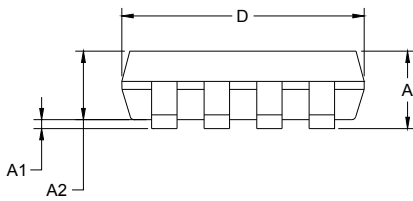

Symbol	Dimensions In Millimeters		Dimensions In Inches	
	MIN	MAX	MIN	MAX
A	0.820	1.100	0.032	0.043
A1	0.020	0.150	0.001	0.006
A2	0.750	0.950	0.030	0.037
b	0.250	0.380	0.010	0.015
c	0.090	0.230	0.004	0.009
D	2.900	3.100	0.114	0.122
E	2.900	3.100	0.114	0.122
E1	4.750	5.050	0.187	0.199
e	0.650 BSC		0.026 BSC	
L	0.400	0.800	0.016	0.031
θ	0°	6°	0°	6°

TAPE AND REEL INFORMATION

REEL DIMENSIONS

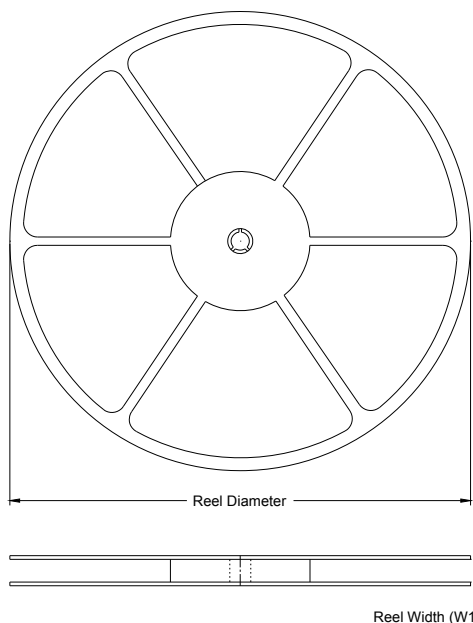

TAPE DIMENSIONS

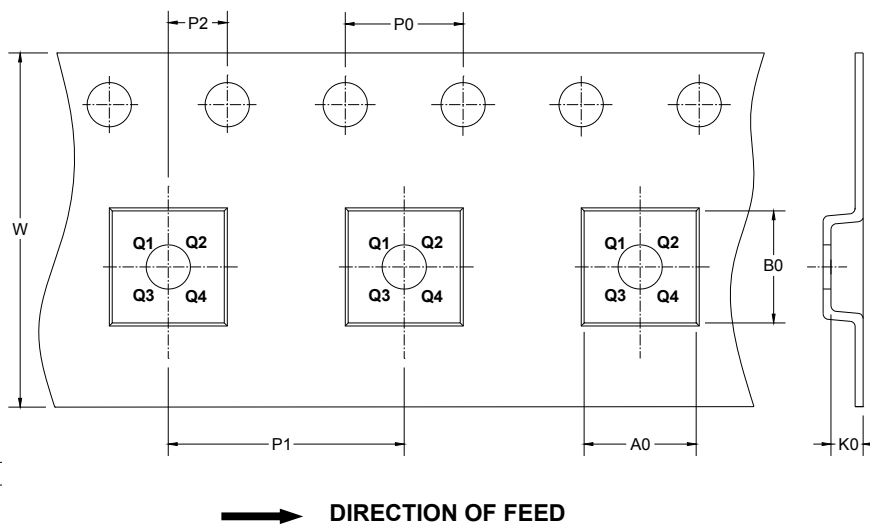

NOTE: The picture is only for reference. Please make the object as the standard.

KEY PARAMETER LIST OF TAPE AND REEL

Package Type	Reel Diameter	Reel Width W1 (mm)	A0 (mm)	B0 (mm)	K0 (mm)	P0 (mm)	P1 (mm)	P2 (mm)	W (mm)	Pin1 Quadrant
MSOP-8	13"	12.4	5.2	3.3	1.5	4.0	8.0	2.0	12.0	Q1

SGM4809

Dual 158mW Headphone Amplifier with Active Low Shutdown Mode

CARTON BOX DIMENSIONS

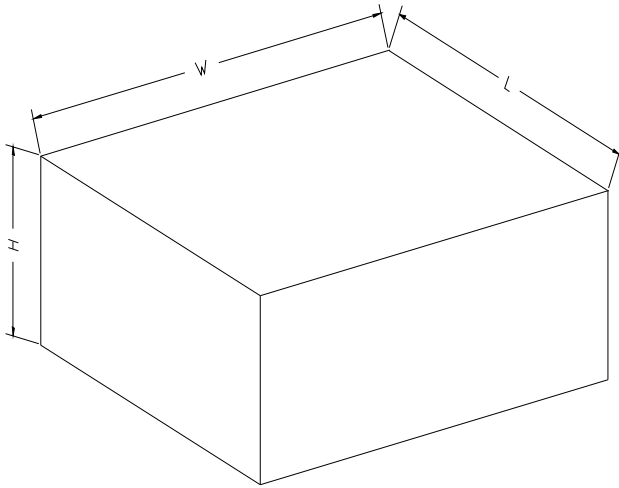

NOTE: The picture is only for reference. Please make the object as the standard.

KEY PARAMETER LIST OF CARTON BOX

Reel Type	Length (mm)	Width (mm)	Height (mm)	Pizza/Carton
13"	386	280	370	5